

DIMENSIONS & DATA CERTIFIED FOR:

Representative:

Order:

Customer:

Order:

Project:

Requirements:

By:

Date:

DIMENSION	A	B
0" FILL HEAD	37	41
6" FILL HEAD	43	47
12" FILL HEAD	49	53

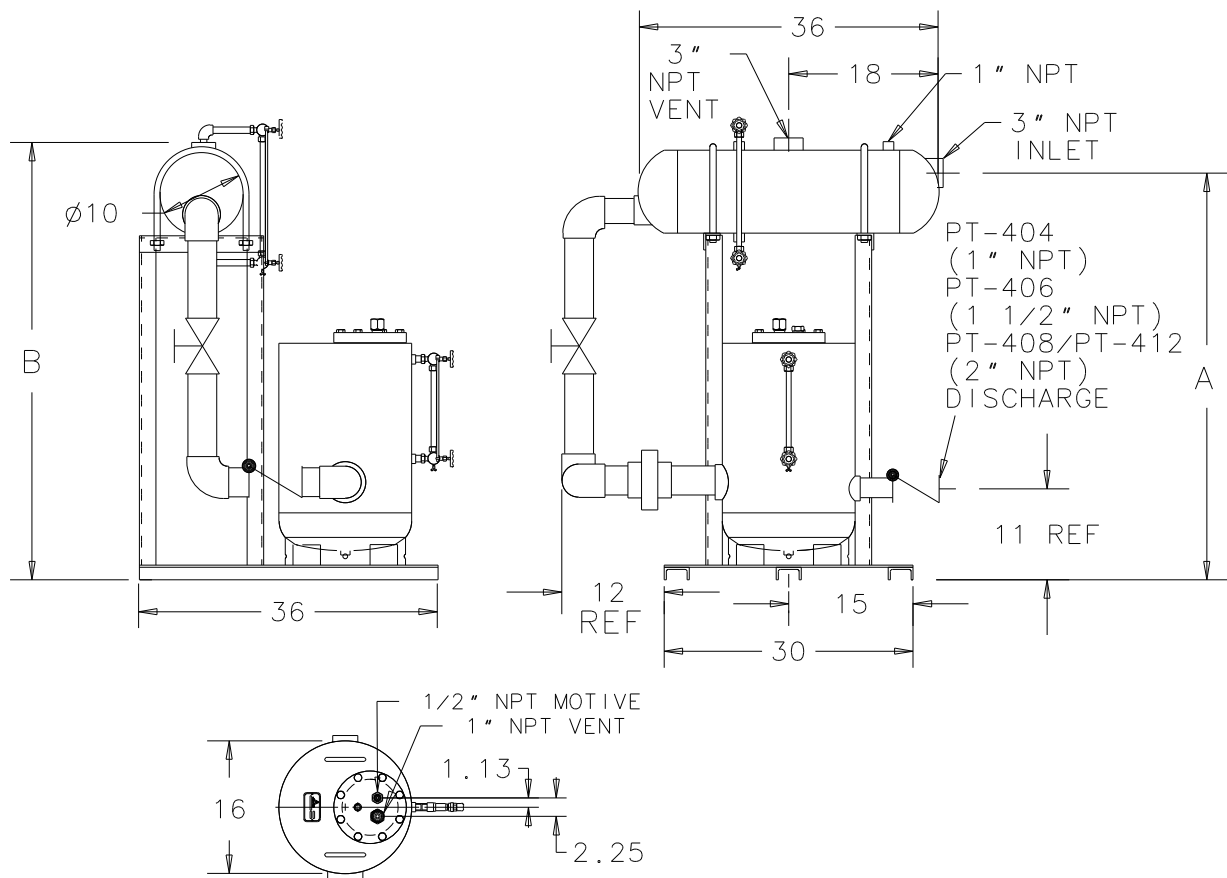

NOTES:

- DRAWING SHOWS OPTIONAL GAUGE GLASSES.
- RECEIVER ASME CODE 150 PSIG
- RECEIVER VOLUME = APPROX. 10 GALLONS
- SEE DRAWING CDF1038 FOR RECEIVER SIZING
- FILL HEAD MUST BE SPECIFIED



Armstrong Condensate Management Group
 Three Rivers, MI. 49093
 Telephone (269) 279-3601
 Fax (269) 279-3150
 Posted on www.armstronginternational.com

Product	CDF No.	Date
SPT-400LBRP-10	CDF 1077	06/21/06
		Rev. A