

# DIMENSIONS & DATA CERTIFIED FOR:

Representative:

Order:

Customer:

Order:

Project:

Requirements:

By:

Date:

DIMENSION	A	B
0" FILL HEAD	24	39
6" FILL HEAD	30	45
12" FILL HEAD	36	51

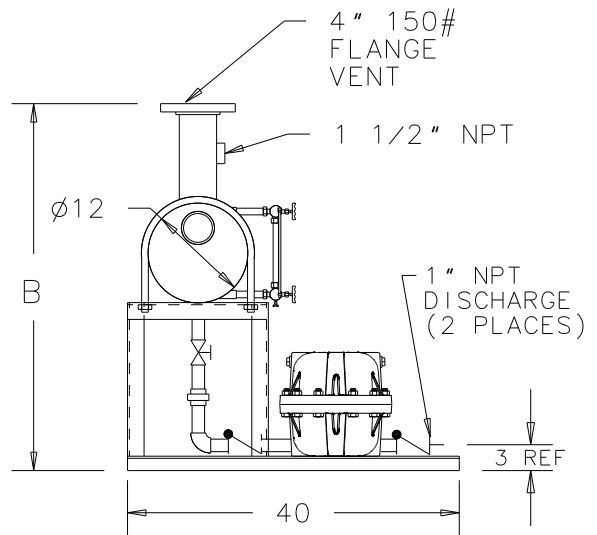
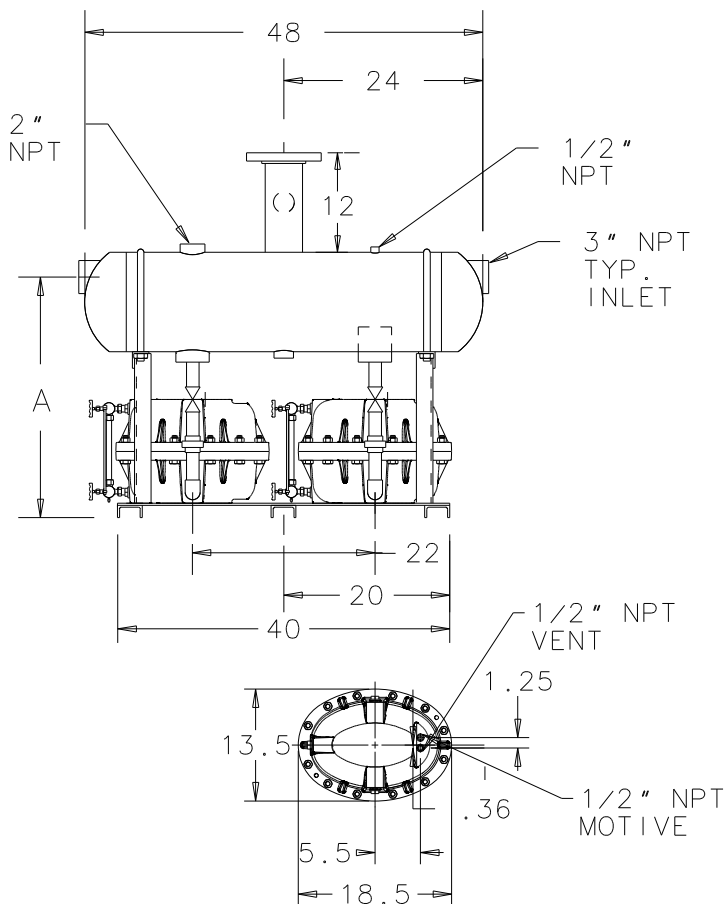

**NOTES:**

1. DRAWING SHOWS OPTIONAL GAUGE GLASSES.
2. RECEIVER ASME CODE 150 PSIG
3. RECEIVER VOLUME: APPROX. 22 GALLONS
4. FILL HEAD MUST BE SPECIFIED



Armstrong Condensate Management Group  
 Three Rivers, MI. 49093  
 Telephone (269) 279-3601  
 Fax (269) 279-3150  
 Posted on [www.armstronginternational.com](http://www.armstronginternational.com)

Product	CDF No.	Date
DPT-104LBRP-12	CDF1070	06/21/06
		Rev. A